



SEL-3505/SEL-3505-3 Real-Time Automation Controller



Major Features and Benefits

The SEL-3505 and SEL-3505-3 Real-Time Automation Controllers (RTAC) combine the power of IEC 61131 PLC logic with the best features of a communications processor in a small, low-power package. With eight digital inputs, three Form C digital outputs, three serial ports, and industry protocols, the SEL-3505-3 is perfect for adding automation to recloser cabinets and other space-limited locations. The SEL-3505 offers four serial ports, one input and one output with an optional internal modem. In this data sheet, SEL-3505 refers to both the SEL-3505 and the SEL-3505-3, unless otherwise specified.

- **Simple Setup.** Build a system quickly using ACCELERATOR RTAC[®] SEL-5033 Software preconfigured templates for SEL relays and other communications connections. The Tag Processor provides methods for visually mapping data relationships between communications protocols.
- **Multiple Functions in One Reliable Device.** Use a single SEL-3505 as a remote terminal unit (RTU), protocol gateway, logic processor, PAC, engineering port server, event processor, and SER logger/viewer.
- **Proven Reliability.** Depend on a rugged device designed and tested to meet or exceed protective relay standards for vibration, electrical surges, fast transients, and extreme temperatures, as well as meet or exceed IEEE 1613, Standard Environmental and Testing Requirements for Communications Networking Devices in Electric Power Substations.
- **IEC 61850.** Integrate high-speed control schemes between the SEL-3505 and relays with IEC 61850 GOOSE peer-to-peer messaging.
- **Standard I/O.** Wire loose field I/O, with as many as eight binary inputs and as many as three binary outputs, directly to the SEL-3505.

- **Protection Against Malware and Other Cybersecurity Threats.** Protect your RTAC system with exe-GUARD[®], which uses advanced cryptographic algorithms to authorize the execution of any program or service on the system. Any tasks not approved by the whitelist are blocked from operation.
- **User Security.** Assign individual user and role-based account authentication and strong passwords. Use Lightweight Directory Access Protocol (LDAP) for central user authentication.
- **Integrated Security Management.** Comply with NERC/CIP user authentication, logging, and port control requirements. Use the integrated light sensor and accelerometer for cabinet intrusion detection.
- **Standard IEC 61131-3 Logic Design.** Create innovative logic solutions directly in ACSELERATOR RTAC by using any of the editor tools: Tag Processor, Structured Text, Ladder Logic, or Continuous Function Chart.
- **Flexible Protocol Conversion.** Apply any available client or server protocol on any serial or Ethernet port. Two of the SEL-3505 and three of the SEL-3505-3 serial ports can be used in software-selectable EIA-232 or EIA-485 mode. Choose optional copper or fiber connectors for the two rear Ethernet ports.
- **Synchrophasor Technology.** Integrate synchrophasor messages from relays or phasor measurement units (PMUs) in your system by using the IEEE C37.118 client protocol. Use these messages for logic and control in the station or convert them to DNP3 or other protocol for SCADA usage.
- **Data Management.** Map and scale data points easily between protocols in small and large systems. You can also normalize IED data into common data types, time-stamp formats, and time zones.
- **Single-Point Engineering Access.** Gain engineering access to station IEDs through a single serial port, dial-up modem, or high-speed network connection.

Product Overview

Seamless System Configuration

ACSELERATOR RTAC is a Microsoft[®] Windows[®] compatible configuration software for offline and online use with the SEL-3505. A project in ACSELERATOR RTAC contains the complete configuration, settings, and logic for an individual RTAC device. Preconfigured device templates are available for you to add all device and master connections to the project tree view.

Once you create the settings for a specific device connection, improve engineering efficiency by saving a custom device template for later use with similar projects. Share custom templates via email or network for even greater savings.

The Tag Processor view facilitates the mapping of operational data quickly between IEDs and SCADA. ACSELERATOR RTAC is compatible with Microsoft Excel[®] and other programs, so you can save time and increase accuracy by copying SCADA maps from the source.

There is no need to install or learn more than one software interface. Use the Structured Text, Ladder Diagram, or Continuous Function Chart editors included with ACSELERATOR RTAC to develop custom IEC 61131 logic.

Data Concentration and Protocol Conversion

Configure each serial or Ethernet port to use any of the client, server, or peer-to-peer protocols available for the SEL-3505. For example, when you use IEEE C37.118 protocol to receive synchrophasor messages, you can map analog or Boolean tags and time stamps to DNP3 and send the data to SCADA very efficiently.

Additionally, when you need to define relay connections in a primary/backup arrangement, use the Tag Processor to map relay tags so that the master stations will receive power system information only from the active relay.

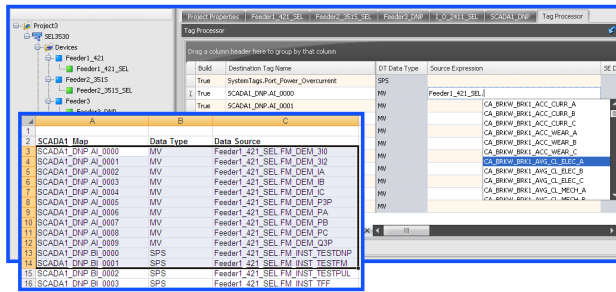

Figure 1 Map Source and Destination Tags Using the Tag Processor or Copy SCADA Maps Directly From a Spreadsheet

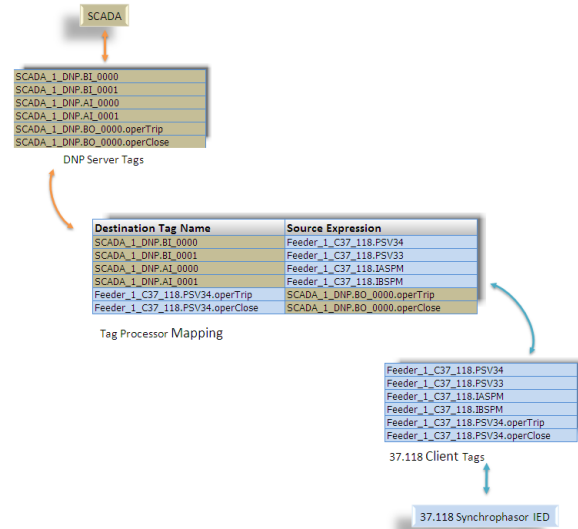
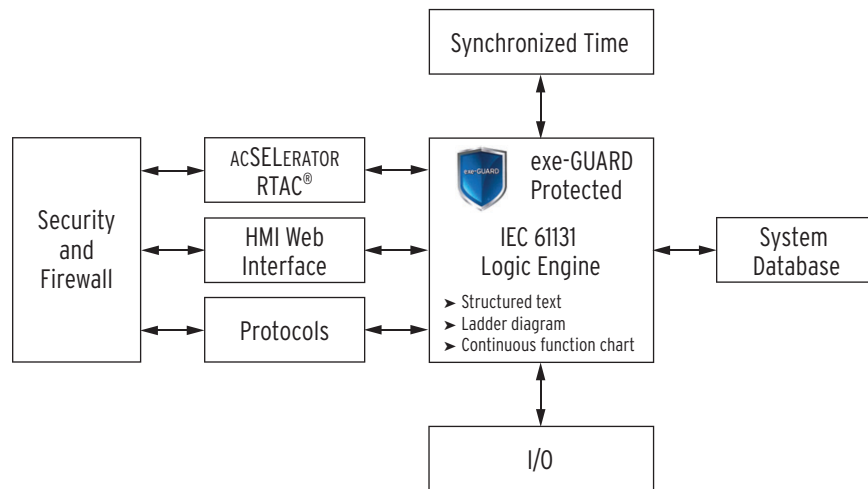

Figure 2 Map Synchronphasor Data Seamlessly Into SCADA Connections

Functional Diagram



IEC 61131 Logic Engine

As depicted in the functional diagram, each SEL-3505 includes an IEC 61131 logic engine that is preconfigured to have access for all system tags, IED data, diagnostics, alarms, security events, and communications statistics for use in integrating your system. The system has no functional separation between those tags mapped for communications protocols and those used in programmable logic. This architecture greatly simplifies system configuration effort because no additional selection is required to identify tags used by the logic engine. You simply use any needed IED data, calculated values, and system tags in deterministic logic for the control of critical applications.

Management of the task-processing sequence and solve rate in the SEL-3505 is similar to that for traditional PLCs or PACs.

Task processing in the logic engine includes protocol I/O, system management, and any custom logic programs you create by using Structured Text (ST), Ladder Logic Diagram (LD), or Continuous Function Charts (CFC). CFC programs are a type of IEC 61131-3 Function Block Diagram (FBD) that provide more programming flexibility than standard FBDs. The ACSELERATOR RTAC software includes the IEC 61131-3 and Tag Processor editors you will use to manage any protocol information and custom logic needed for your system.

Manage User Accounts and Alarms in Web Server

The built-in SEL-3505 web interface provides the ability to manage user accounts and system alarms remotely. Each user account has a unique user name, password, and assigned role that defines system permissions. You can also configure the SEL-3505 to use LDAP central authentication for user account management. The system includes web pages for monitoring user logs and maintaining network policies.

Logged tag values and system events provide a system-wide Sequence of Events report. View the logs online or use ODBC connectivity to download them to a central database.

You can also configure Ethernet connections and monitor system status from the web interface. All of the Ethernet ports can operate on independent networks, or you can bind them for failover operation.

Flexible Engineering Access

Access Point Routers in the SEL-3505 provide a means for creating transparent connections between any two ports. A transparent connection is a method for using the SEL-3505 as a port server to connect remotely to an IED. Simple logic in the SEL-3505 enables remote engineering access only through supervisory commands.

Applications

Substation SCADA, Report Retrieval, Engineering Access, and Alarm Notification

The SEL-3505 can act as a data concentrator by using protocols such as Modbus[®], DNP3, or MIRRORING BITS[®] communications to integrate both serial and Ethernet IEDs. Enable logging on any system or IED tag to view and archive a station-wide event record.

The SEL-3505 Ethernet connection provides a means to remotely access the system to monitor logs and diagnostics. First establish a remote connection with any IED connected to the SEL-3505 through Engineering Access communications channels. Then use the ACCELERATOR RTAC software suite to manage protection and control settings for these relays remotely.

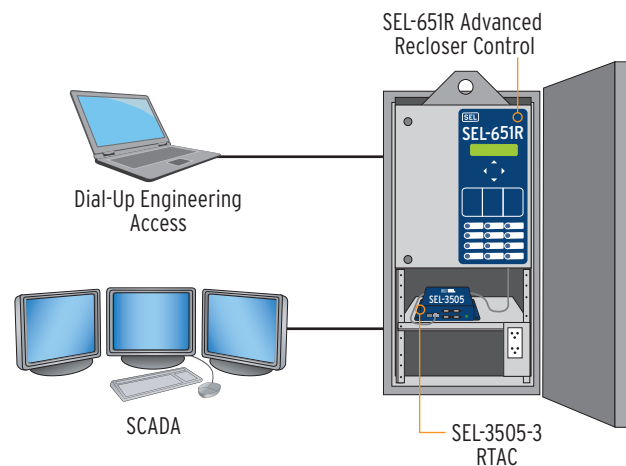

Synchrophasor Integration and Control

The SEL-3505 can integrate synchrophasor messages from the IEEE C37.118 protocol into SCADA protocols, such as DNP3 or Modbus. Easily include the source PMU time stamps and time quality attributes in the SCADA message to allow for system-wide usage of synchrophasor data.

Within the SEL-3505 logic engine, you can perform complex math and logic calculations on synchrophasor data from C37.118-compliant devices.

The SEL-3505 also synchronizes the time clocks in attached devices that accept a demodulated IRIG-B time signal. The SEL-3505 regenerates the demodulated IRIG-B signal from a demodulated source; this signal is precise enough for synchrophasor applications.

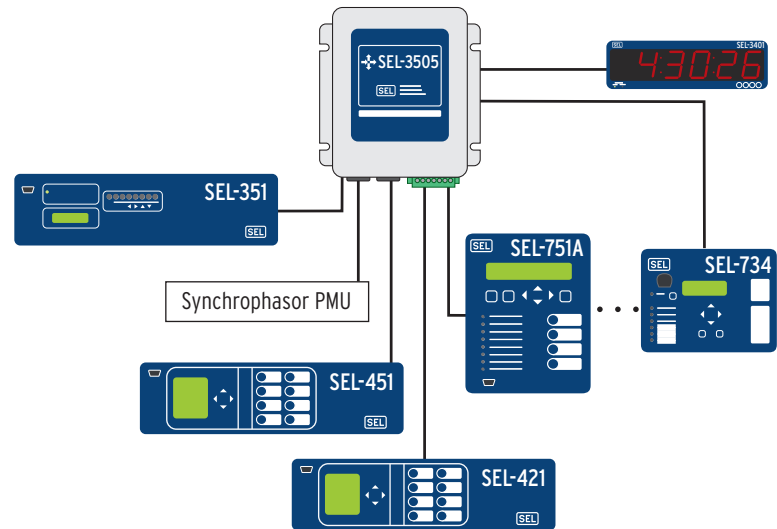

Real-Time Control and Logic Processing

The built-in logic processor provides high-speed control and transfer of signals from SEL MIRRORING BITS devices or devices using other protocols. The SEL-3505 can serve as the system controller and SCADA gateway to eliminate costly equipment (such as breakers, interposing relays, and wiring) while also reducing engineering and labor costs.

The intuitive ACCELERATOR RTAC software provides simple setup of analog and binary tags from any device in the system. Integrated tools scale values and create logic in a flexible IEC 61131-3 configuration environment.

Take advantage of multi-protocol support to collect SCADA information, process control commands, and use NTP time synchronization through a single communications link to each Ethernet device.

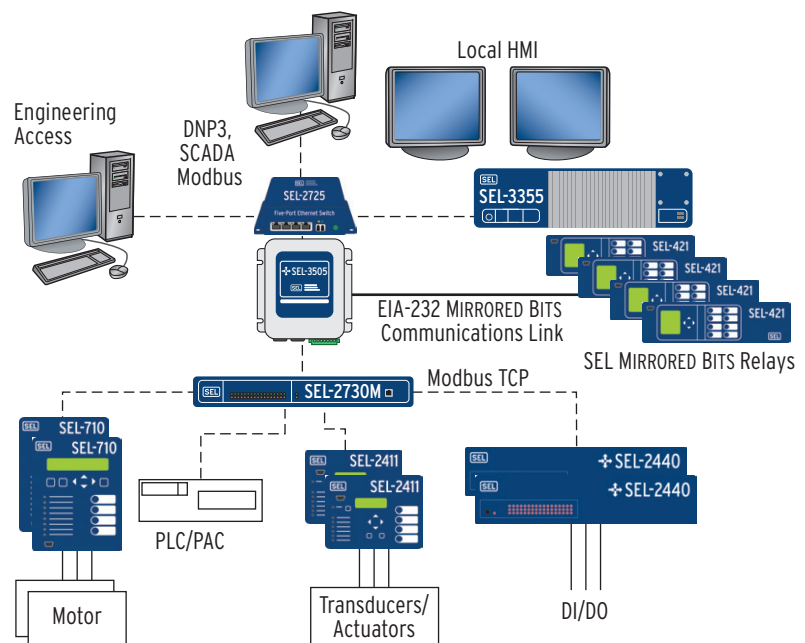

Secure Communication and User Management

The SEL-3505 and SEL accessories offer security for your automation network. Per-user security profiles provide compliance with role-based requirements. The system can employ intrusion detection, notification, and logging to help maintain perimeter integrity.

The SEL-3505 includes security features so that your system complies with NERC/CIP requirements for auditing, logging, port control, web authentication, and password restrictions. The SEL-3505 also supports central authentication through your existing LDAP server.

By including SEL serial and wireless encrypting devices with the SEL-3505, you can protect remote serial communication to recloser controls or other connected devices.

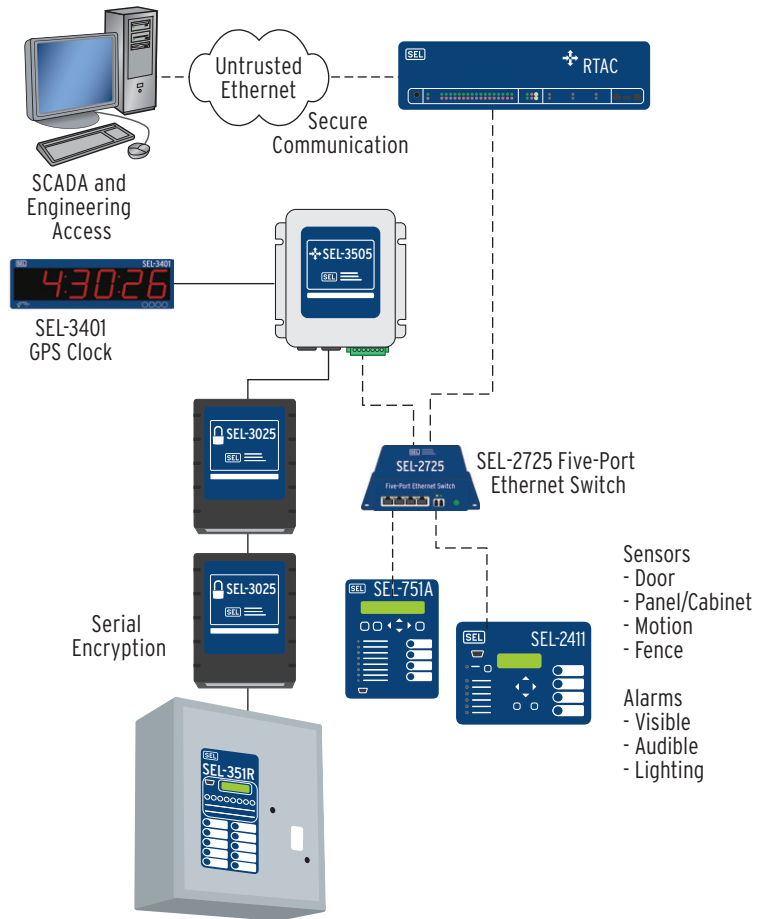

Control Systems

The custom logic, communications protocols, and I/O in the SEL-3505, SEL-2411, and SEL-2440 permit you to implement complete control systems, whether you perform discrete sequences, continuous control, monitoring, or asset management. SEL subjects its products to tests for harsh environments, so you can be confident that your control system will work reliably in tough applications. Minimize loop wiring and simplify commissioning by installing controls close to process equipment and integrating them with industry standard communications protocols. Additionally, the SEL-3355 Embedded Automation Computer can provide HMI and data archiving functions.

Use a powerful IEC 61131 logic engine to design custom control programs in the SEL-3505. You can set the logic solve rate and program execution order to meet your system requirements. Operate the SEL-3505 as a master controller and use SELOGIC® control equations in the SEL-2411 and SEL-2440 to perform distributed sequential or continuous control algorithms.

With a variety of physical interfaces and open protocol options, the SEL-3505 makes system integration simple. It will reduce engineering time and complexity, so that you can focus on improving productivity and efficiency rather than on fixing communications problems.

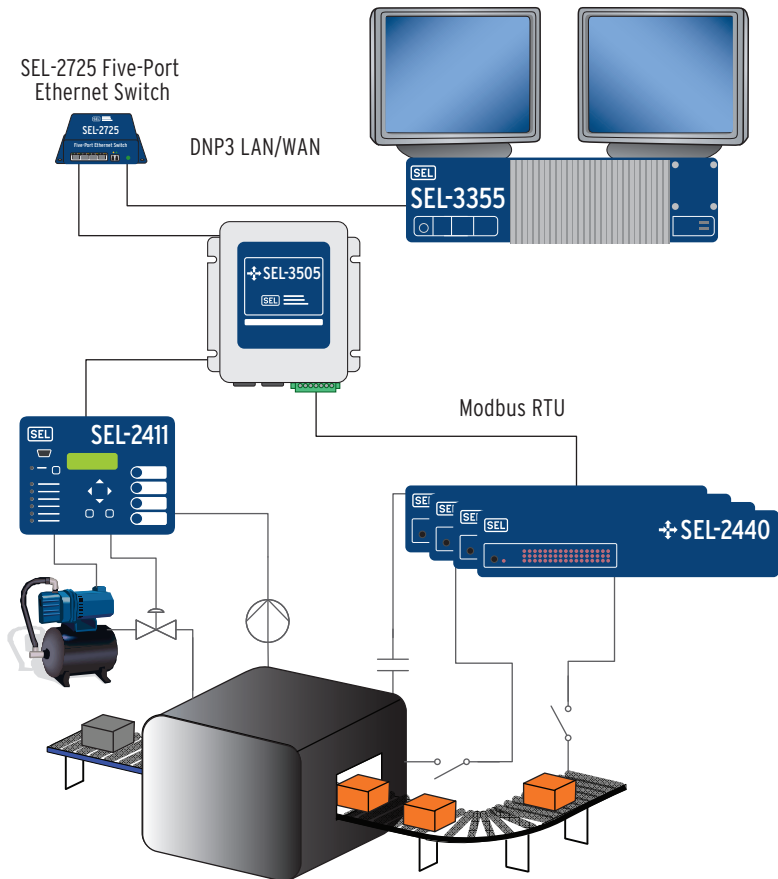

Ordering Options

Table 1 SEL-3505 Ordering Options

Ethernet Communication	2 rear Ethernet ports, 10/100BASE-T copper (standard), 100BASE-FX multi-mode fiber optics (optional), 100BASE-LX single-mode fiber optics (optional)	Environment	Conformal coating for chemically harsh and high-moisture environments
Power Supply	12–24 Vdc 24–48 Vdc	Mounting	DIN-rail mount Surface mount
		Modem	Integrated 56 kbps dial-up modem (SEL-3505 only)

Panel Features

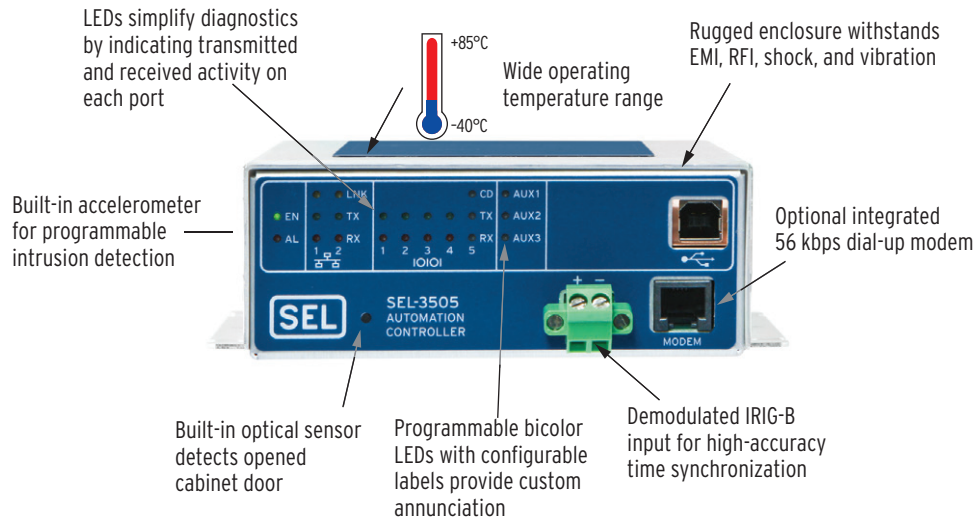

Figure 3 SEL-3505 Front-Panel View

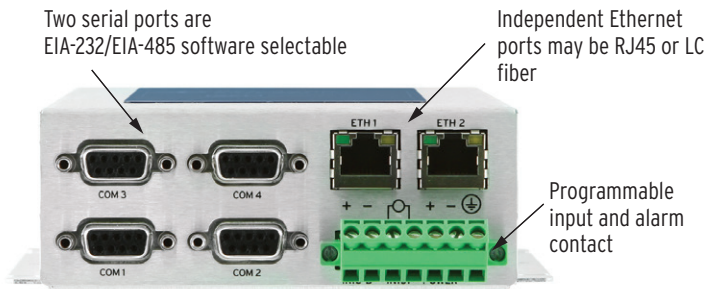

Figure 4 SEL-3505 Rear-Panel View

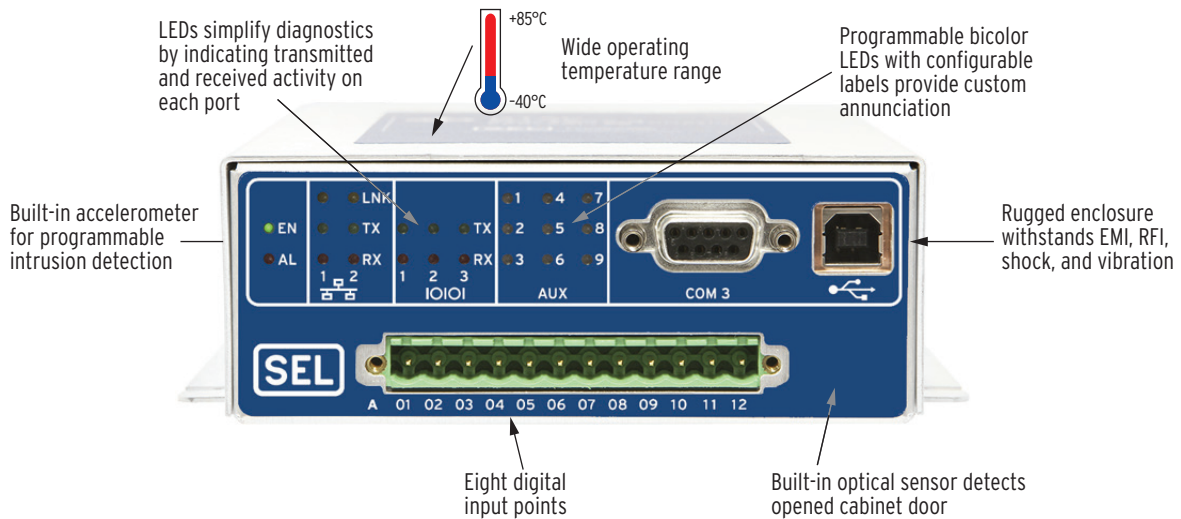

Figure 5 SEL-3505-3 Front-Panel View

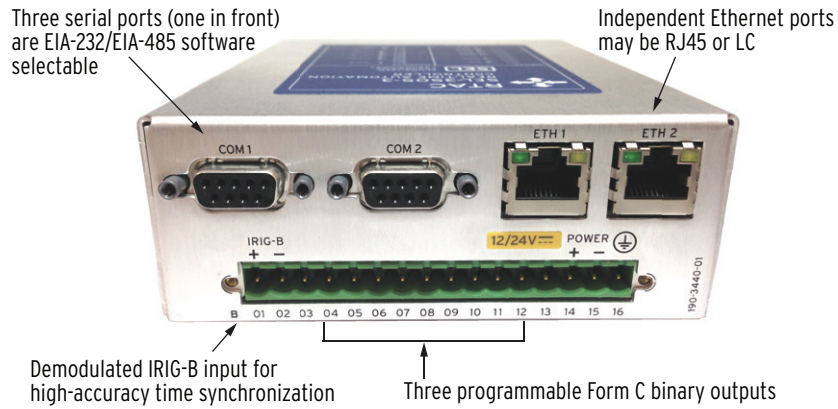

Figure 6 SEL-3505-3 Rear-Panel View

Dimensions

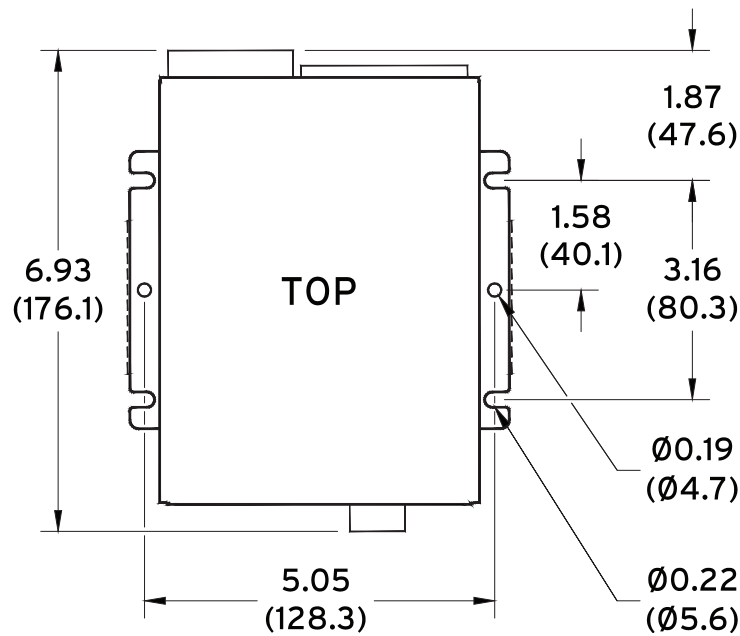

Figure 7 SEL-3505 Surface-Mount Dimensions

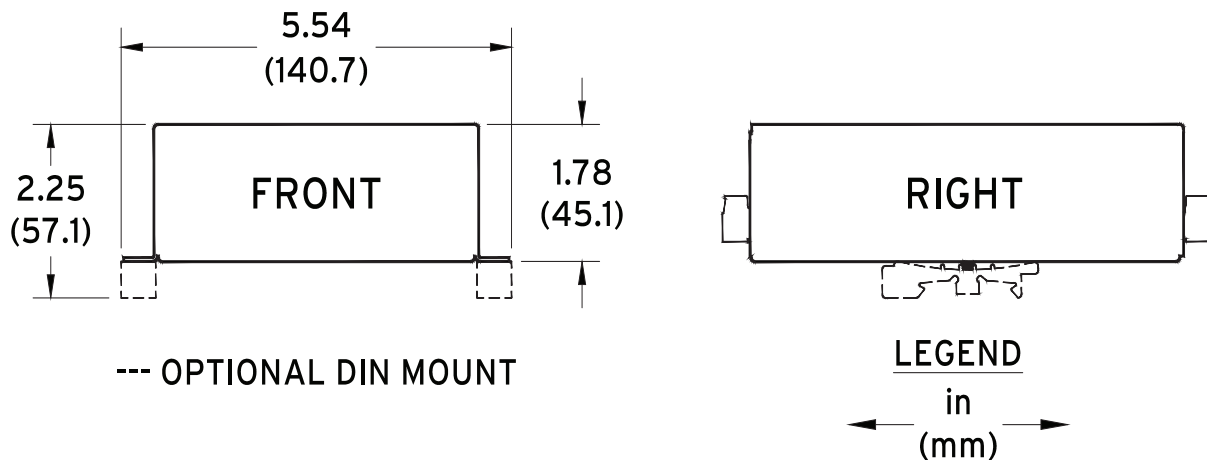

Figure 8 SEL-3505 DIN-Mount Dimensions

Specifications

Compliance

Designed and manufactured under an ISO 9001 certified quality management system

47 CFR 15B, Class A

Note: This equipment has been tested and found to comply with the limits for a Class A digital device, pursuant to part 15 of the FCC Rules. These limits are designed to provide reasonable protection against harmful interference when the equipment is operated in a commercial environment. This equipment generates, uses, and can radiate radio frequency energy and, if not installed and used in accordance with the instruction manual, may cause harmful interference to radio communications. Operation of this equipment in a residential area is likely to cause harmful interference, in which case the user will be required to correct the interference at his own expense.

UL Certified to U.S. and Canadian safety standards (File E220228; NRAQ, NRAQ7)

CE Mark (does not apply to units with dial-up modem)

General

Operating System

SEL Linux® Yellowstone running Linux kernel 3.x with real-time preemption patches

Operating Temperature Range

-40° to +85°C (-40° to +185°F)

Note: Not applicable to UL applications.

Operating Environment

Pollution Degree: 2

Overvoltage Category: II

Insulation Class: Class I equipment

Relative Humidity: 5%–95%, noncondensing

Maximum Altitude: 2000 m

Weight (Maximum)

2.27 kg (5 lb)

Processing and Memory

Processor Speed: 333 MHz

Memory: 512 MB DDR2 ECC RAM

Storage: 2 GB

Security Features

Account Management: User Accounts
User Roles
LDAP Central Authentication
RADIUS Central Authentication
Strong Passwords
Inactive Account Logouts

Intrusion Detection: Access/Audit Logs
Alarm LED
Light Sensor
3-Axis Accelerometer

Encrypted Communication: SSL/TLS, SSH
HTTPS

Automation Features

Protocols

Client

DNP3 Serial, DNP3 LAN/WAN, Modbus RTU, Modbus TCP, SEL ASCII, SEL Fast Messaging, LG 8979, IEC C37.118, CP2179, SNMP, SES-92, CDC Type II, Courier, IEC 60870-5-103, EtherNet/IP Explicit Message Client

Server

DNP3 Serial, DNP3 LAN/WAN, Modbus RTU, Modbus TCP, SEL Fast Messaging, LG 8979, SES 92, IEC 61850 MMS, IEC 60870-5-101/104, IEEE C37.118, FTP, SFTP, CDC Type II, EtherNet/IP Implicit Message Adapter

Peer-to-Peer

IEEE-61850 GOOSE, SEL MIRRORRED BITS Communications, Network Global Variables (NGVL), Parallel Redundancy Protocol

Engineering Access

Modes: SEL Interleaved, Direct

Port Server: Map Serial Ports to IP Ports

Secure Web Server: Diagnostic and Communications Data

Time-Code Input (Demodulated IRIG-B)

On (1) State: $V_{ih} \geq 2.2 \text{ V}$

Off (0) State: $V_{il} \leq 0.8 \text{ V}$

Input Impedance: 1.5 k Ω

Accuracy: 250 ns

Time-Code Output (Demodulated IRIG-B)

On (1) State: $V_{oh} \geq 2.4 \text{ V}$

Off (0) State: $V_{ol} \leq 0.8 \text{ V}$

Load: 50 Ω

Output Drive Levels

Serial Port: TTL 5 mA, 2.4 Vdc, 500 Ω

Network Time Protocol (NTP) Modes

NTP Client: As many as three configurable servers

NTP Server

Precise Time Protocol (PTP)

PTP Client: Peer delay request and end-to-end path delay supported

Communications Ports

Ethernet Ports

Ports: 2 rear

Data Rate: 10 or 100 Mbps

Rear Connectors: RJ45 Female or LC Fiber (single-mode or multimode, 100 Mbps only)

SEL-3505 Serial Ports

Ports: 4

Type: 2 EIA-232 (Ports 1 and 2)
2 EIA-232/EIA-485 (software selectable on Ports 3 and 4)

Data Rate: 300 to 115200 bps

Connector: DB-9 Female

Time Synchronization: IRIG-B

SEL-3505-3 Serial Ports

Ports: 3

Type: EIA-232/EIA-485 (software selectable)

Data Rate: 300 to 115200 bps

Connector: DB-9 Female

Time Synchronization: IRIG-B

USB Ports

Ports: 1

1 Device Port: Type B

Fiber Optics (Class 1 LASER/LED)

Product:	IEC 60825-1:1993 + A1:1997 + A2:2001
Data Rate:	100 Mbps
Connector Type:	LC
Wavelength:	1300 nm
Multimode Option:	62.5 μ m fiber
TX Max. Power:	-14 dBm
TX Min. Power:	-20 dBm
RX Sensitivity:	-31 dBm
RX Overload:	-14 dBm
Min. TX Level:	-20 dBm
Min. RX Sensitivity:	-31 dBm
Optical Budget:	11 dBm
Max. Distance:	2 km
Single-Mode Option:	9 μ m fiber
TX Max. Power:	-8 dBm
TX Min. Power:	-15 dBm
RX Sensitivity:	-25 dBm
RX Overload:	-8 dBm
Min. TX Level:	-15 dBm
Min. RX Sensitivity:	-25 dBm
Optical Budget:	10 dBm
Max Distance:	15 km

SEL-3505 Input (Units Manufactured Prior to April 2017)

Optoisolated Control Inputs

Software Settings:	
ON:	15–30 Vdc
OFF:	<5 Vdc
Pickup/Dropout Delay:	1–30000 ms
Current Draw at Nominal DC Voltage:	2–4 mA

Optoisolated Control Inputs

4 Input Ranges:		
12 V:	ON: 9.6–18 Vdc	OFF: <7.2 Vdc
24 V:	ON: 19.2–28.8 Vdc	OFF: <11 Vdc
48 V:	ON: 38.4–52.8 Vdc	OFF: <28.8 Vdc
125 V:	ON: 100–135.5 Vdc	OFF: <75 Vdc

Current Draw at Nominal

DC Voltage:	12 V: 2–6 mA
	24 V: 4–7 mA
	48 V: 2–5 mA
	125 V: 2–4 mA

Solid-State Output (SEL-3505 Units Manufactured Prior to April 2017)

100 mA continuous	
0–250 Vac/Vdc Operational Voltage	
Max. On Resistance:	50 Ω
Min. Off Resistance:	10 M Ω
Insulation:	2500 Vac
Wiring size:	14 AWG Max. 26 AWG Min. 0.4 mm Min. Insulation 105°C, 250 V Min.

Electromechanical Outputs

Mechanical Durability: 10 M no-load operations

DC Output Ratings

Voltage:	250 Vdc
Rated Voltage Range:	19.2–275 Vdc
Rated Insulation Voltage:	300 Vdc
Make:	30 A @ 250 Vdc per IEEE C37.90
Continuous Carry:	6 A @ 70°C; 4 A @ 85°C
Contact Protection:	360 Vdc, 40 J MOV protection across open contacts

Operation Time (Coil Energization to Contact Closure, Resistive Load): Pickup/Dropout Time \leq 8 ms typical

Breaking Capacity (10,000 Operations):
48 V 0.50 A L/R = 40 ms
125 V 0.30 A L/R = 40 ms

Cyclic Capacity (2.5 Cycle/Second):
48 V 0.50 A L/R = 40 ms
125 V 0.30 A L/R = 40 ms

Note: Make per IEC 60255-0-20:1974.

AC Output Ratings

Rated Operational Voltage:	240 Vac
Rated Insulation Voltage:	300 Vac
Utilization Category:	AC-15 (control of electromechanic loads > 72 VA)
Contact Rating Designation:	B300 (B = 5 A, 300 = rated insulation voltage)
Contact Protection:	270 Vac, 40 J
Continuous Carry:	3 A @ 120 Vac 1.5 A @ 240 Vac
Rated Frequency:	50/60 \pm 5 Hz
Operating Time (coil energization to contact closure):	Pickup/Dropout Time \leq 8 ms
Electrical Durability Make VA Rating:	3600 VA, $\cos\phi = 0.3$
Electrical Durability Break VA Rating:	360 VA, $\cos\phi = 0.3$

Power Supply

Complies with IEC HiPot and Impulse standards, except when connected to substation battery. The auxiliary (power supply) circuit must be connected to a battery (or other external power supply meeting application requirements) that is not used for switching inductive loads and will provide the required hold-up time.

Input Voltage

Rated Voltage:	12–24 Vdc 24–48 Vdc
----------------	------------------------

Note: 12 V power supply rating does not meet the minimum operating voltage requirement of IEEE 1613.

Operational Voltage Range:	9.8–30 Vdc polarity dependent 19.2–57.6 Vdc polarity dependent
----------------------------	---

Peak Inrush Current

12 Vdc:	19 A
24 Vdc:	44 A
48 Vdc:	91 A

Power Consumption

DC:	7 W (with dual fiber Ethernet) 5 W (with dual copper Ethernet)
-----	---

Fuse Rating (Internal)

F1	
Type:	time lag T
Current Rating:	3.15 A
Voltage Rating:	250 Vac, 300 Vdc
IEC 60127-2/5:	H = 1500 A @ 250 Vac, p.f. = 0.7 – 0.8
UL 248-14:	10 kA @ 125 Vac, p.f. = 0.7 – 0.8 / 1500 A @ 250 Vac p.f. = 0.7 – 0.8 / 1500 A @ 300 Vdc

Product Standards

Communications Equipment in Utility Substations:	IEC 61850-3:2013 IEEE 1613-2009 Severity Level: Class 1 (excluding dial-up modem)
Measuring Relays and Protection Equipment:	IEC 60255-26:2013* IEC 60255-27:2013

* Acceptance Criteria C applied to 0% dc voltage dips for 10 ms. The auxiliary (power supply) circuit is intended to be connected to a battery (or other external power supply meeting application requirements) that is not used for switching inductive loads and will provide the required hold-up time.

Type Tests**Environmental Tests**

Enclosure Protection:	IEC 60529:2001 + CRGD:2003 Severity Level: IP30 (excluding the terminal blocks)
Vibration Resistance:	IEEE 1613-2009 IEC 60255-21-1:1988 Severity Level: Endurance Class 2 Response Class 2
Shock Resistance:	IEEE 1613-2009 IEC 60255-21-2:1988 Severity Level: Shock Withstand, Bump Class 1 Shock Response Class 2
Seismic:	IEC 60255-21-3:1993 Severity Level: Quake Response Class 2
Cold, Operational and Storage:	IEC 60068-2-1:2007 Severity Level: –40°C, 16 hours
Dry Heat, Operational and Storage:	IEC 60068-2-2:2007 Severity Level: 85°C, 16 hours
Damp Heat, Cyclic:	IEC 60068-2-30:2005 Severity Level: 25°–55°C, 6 cycles, 95% relative humidity
Damp Heat, Steady State:	IEC 60068-2-78:2012 Severity Level: 40°C, 240 hours, 93% relative humidity

Dielectric Strength and Impulse Tests

The following standards only apply if the device is not connected directly to the station battery.

Dielectric (HiPot):	IEC 60255-27:2013 IEEE C37.90-2005 Class B, Section 8: Dielectric Tests Dielectric Strength Section Severity Level: 2500 Vac for one minute on contact inputs, contact outputs 1600 Vdc for one minute on power supply
Impulse:	IEC 60255-27:2013 IEEE C37.90-2005 Class B Severity Level: 0.5 J, 2.5 kV

RFI and Interference Tests**EMC Immunity**

Electrostatic Discharge Immunity:	IEEE C37.90.3-2001 IEC 61000-4-2:2008 Severity Level: 2, 4, 6, 8 kV contact discharge; 2, 4, 8, 15 kV air discharge
Magnetic Field Immunity:	IEC 61000-4-8:2009 Severity Level: 1000 A/m for 3 seconds, 100 A/m for 1 minute IEC 61000-4-9:2001 Severity Level: 1000 A/m
Power Supply Immunity:	IEC 61000-4-11:2004 IEC 61000-4-17:1999 + A1:2001 + A2:2008 IEC 61000-4-29:2000
Radiated RF Immunity:	IEC 61000-4-3:2010 Severity Level: 10 V/m, excluding dial-up modem IEEE C37.90.2-2004 Severity Level: 35 V/m, excluding dial-up modem
Fast Transient, Burst Immunity:	IEC 61000-4-4:2012 Severity Level: 4 kV @ 5.0 kHz 2 kV @ 5.0 kHz for comm. ports
Surge Withstand Capability Immunity:	IEEE C37.90.1-2002 Severity Level: 2.5 kV oscillatory 4 kV fast transient Excluding dial-up modem IEC 61000-4-18:2006 + A1:2010 Severity Level: 2.5 kV common-mode 1.0 kV differential-mode 1 kV common-mode on comm. ports
Surge Immunity:	IEC 61000-4-5:2005 Severity Level: 1 kV line-to-line 2 kV line-to-earth 2 kV comm. ports
Conducted RF Immunity:	IEC 61000-4-6:2008 Severity Level: 10 Vrms
Digital Radio Telephone RF Immunity:	ENV 50204:1995 Severity Level: 10 V/m at 900 MHz and 1.89 GHz
EMC Emissions	
Radiated and Conducted Emissions:	CISPR 11:2009 + A1:2010 CISPR 22:2008 ANSI C63.4-2014 Class A Canada ICES-001 (A) / NMB-001 (A)

Notes

© 2012–2022 by Schweitzer Engineering Laboratories, Inc. All rights reserved.

All brand or product names appearing in this document are the trademark or registered trademark of their respective holders. No SEL trademarks may be used without written permission. SEL products appearing in this document may be covered by U.S. and Foreign patents.

Schweitzer Engineering Laboratories, Inc. reserves all rights and benefits afforded under federal and international copyright and patent laws in its products, including without limitation software, firmware, and documentation.

The information in this document is provided for informational use only and is subject to change without notice. Schweitzer Engineering Laboratories, Inc. has approved only the English language document.

This product is covered by the standard SEL 10-year warranty. For warranty details, visit selinc.com or contact your customer service representative.

SCHWEITZER ENGINEERING LABORATORIES, INC.

2350 NE Hopkins Court • Pullman, WA 99163-5603 U.S.A.
Tel: +1.509.332.1890 • Fax: +1.509.332.7990
selinc.com • info@selinc.com

